

## MAGIQ WALLWASH TRIMLESS

**A35139-** \_\_\_\_\_

base number \_\_\_\_\_  
 Color \_\_\_\_\_  
 Temperature \_\_\_\_\_  
 Finish \_\_\_\_\_  
 Options \_\_\_\_\_

- To build a product code in our configurator select the specify button on the base model # product page
- To build a manual product code on this datasheet choose from the options listed below in blue font and add the suffix to the base model #

### GENERAL

Series: Magiq Wallwash  
 Brand: Prolicht  
 Division: Architectural  
 Mounting Type: Trimless  
 Mounting Location: Ceiling  
 Subcategory: Wallwash

### PHYSICAL

Shape: Rectangle  
 Length (mm): 267  
 Length (in): 10 1/2  
 Width (mm): 36  
 Width (in): 1 7/16  
 Height (mm): 64  
 Height (in): 2 1/2  
 Ceiling Thickness (mm): 12.5  
 Ceiling Thickness (in): 1/2  
 Min. Recessing Depth (mm): 100  
 Min. Recessing Depth (in): 3 15/16  
 Light Distribution: Asymmetric  
 Weight (kg): 0.943  
 Weight (lbs): 2.08  
 Holder Finish: WHI / BLK  
 Fixture Material: Aluminum Die Cast  
 Cut-out Measurements: 273mm / 10 3/4" x 42mm / 1 5/8"  
 Upon Request: Unique Ceiling Thickness

### ELECTRICAL

Lamp Type: LED (Zhaga Standard)  
 Input Wattage (W): 33.4  
 Total Output Wattage (W): 29.6  
 Dimming: Tri-Mode (Non-Dimming and Phase Dimming (120Vac only) and 0-10V Dimming)  
 Driver Included: Yes  
 Driver Location: Remote  
 Driver Type: Constant Current - Universal  
 Driver Class: Class 1  
 Input Voltage (V): 120 - 277  
 Constant Current (MA): 500

### LED

Number of LEDs: 5  
 Color Temperature (°K): 2700 / 3000 / 3500 / 4000  
 Max. Delivered Lumen (lm): 2145 / 2339 / 2145 / 2443  
 Nominal Lumen (lm): 2375 / 2590 / 2375 / 2705  
 CRI: >90 CRI  
 Lamp Life (hrs): 50000  
 Upon Request: Special Color Temperature

### OPTICAL

Reflector: Asymmetric  
 Upon Request: Special Beam Angles

### RATINGS AND CERTIFICATIONS

Certified By: CSA Certified to UL and CSA Standards  
 IP rating: IP20

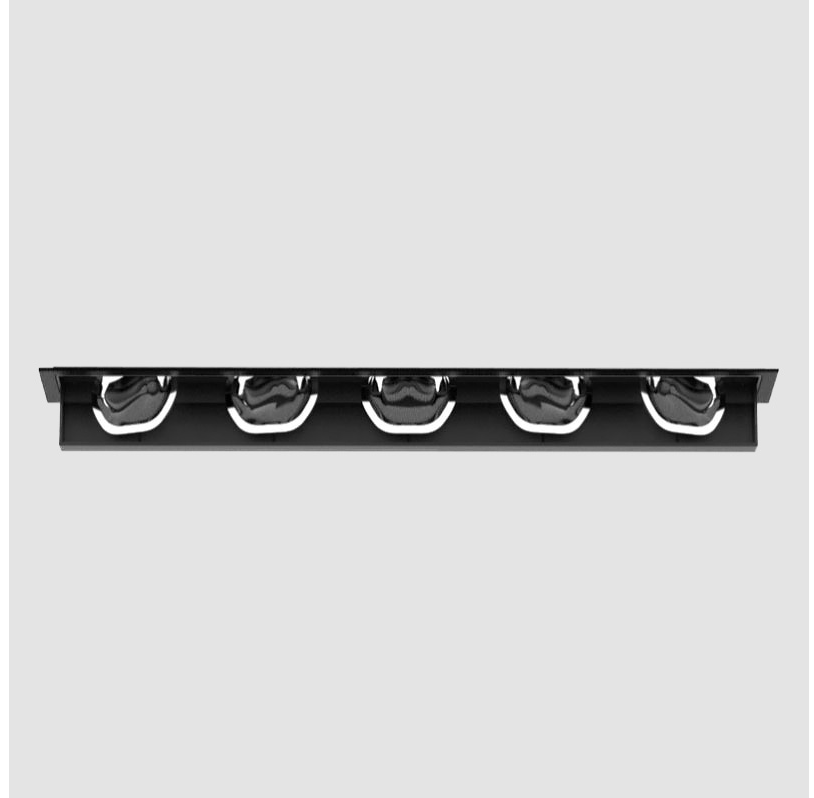

100mm  
3 15/16"

12 1/2 mm  
1/2"

270mm x 38mm  
10 5/16" x 1 1/2"



## MAGIQ WALLWASH TRIMLESS

A35139-

PROJECT \_\_\_\_\_

TYPE \_\_\_\_\_

SPECIFIER \_\_\_\_\_

QUANTITY \_\_\_\_\_

DATE \_\_\_\_\_



## MAGIQ WALLWASH RECESSED

**A35154-**

base number    Color    Finishes    Finish  
 Temperature    (Diamond)    Options

- To build a product code in our configurator select the specify button on the base model # product page
- To build a manual product code on this datasheet choose from the options listed below in blue font and add the suffix to the base model #

### GENERAL

Series: Magiq Wallwash  
 Brand: Prolicht  
 Division: Architectural  
 Mounting Type: Recessed  
 Mounting Location: Ceiling  
 Subcategory: Wallwash

### PHYSICAL

Shape: Rectangle  
 Length (mm): 277  
 Length (in): 10 <sup>7</sup>/<sub>8</sub>  
 Width (mm): 45  
 Width (in): 1 <sup>3</sup>/<sub>4</sub>  
 Height (mm): 64  
 Height (in): 2 <sup>1</sup>/<sub>2</sub>  
 Min. Recessing Depth (mm): 100  
 Min. Recessing Depth (in): 3 <sup>15</sup>/<sub>16</sub>  
 Light Distribution: Asymmetric  
 Fixture Finish: SSR / BKV / CWI / CRY / HAB / UFT / ITA / RUA / FTG / MYG / LOD / PUS / FRO / FUP / KIA / POP / BLS / SPG / MEY / GOH / GUM / CHC / COM / ABZ / JAG / OBR / MOS / ROR  
 Holder Finish: WHI / BLK  
 Fixture Material: Aluminum Die Cast  
 Cut-out Measurements: 270mm / 10 5/8" x 38mm / 1 1/2"

### ELECTRICAL

Lamp Type: LED (Zhaga Standard)  
 Input Wattage (W): 31.4  
 Total Output Wattage (W): 25.9  
 Dimming: Tri-Mode (Non-Dimming and Phase Dimming (120Vac only) and 0-10V Dimming)  
 Driver Included: No  
 Driver Location: Remote  
 Driver Type: Constant Current - Universal  
 Driver Class: Class 1  
 Input Voltage (V): 120 - 277  
 Constant Current (MA): 500

### LED

Number of LEDs: 5  
 Color Temperature (°K): 2700 / 3000 / 3500 / 4000  
 Max. Delivered Lumen (lm): 2145 / 2339 / 2145 / 2443  
 Nominal Lumen (lm): 2375 / 2590 / 2375 / 2705  
 CRI: >90 CRI  
 Efficiency (%): 82.3  
 Lamp Life (hrs): 50000

### OPTICAL

#### RATINGS AND CERTIFICATIONS

Certified By: CSA Certified to UL and CSA Standards  
 IP rating: IP20

|           |
|-----------|
| PROJECT   |
| TYPE      |
| SPECIFIER |
| QUANTITY  |
| DATE      |

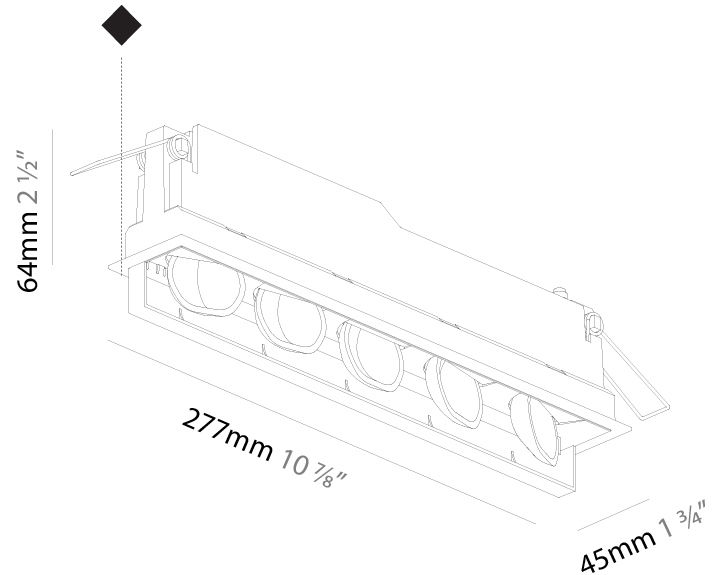

100mm  
3 <sup>15</sup>/<sub>16</sub>"

5 - 30 mm  
<sup>3</sup>/<sub>16</sub>" - 1 <sup>3</sup>/<sub>16</sub>"

270mm x 38mm  
10 <sup>5</sup>/<sub>8</sub>" x 1 <sup>1</sup>/<sub>2</sub>"

A

## MAGIQ WALLWASH RECESSED

A35154-

PROJECT \_\_\_\_\_

TYPE \_\_\_\_\_

SPECIFIER \_\_\_\_\_

QUANTITY \_\_\_\_\_

DATE \_\_\_\_\_



A

## MAGIQ WALLWASH COLOR FINISH CHART

PROJECT \_\_\_\_\_  
 TYPE \_\_\_\_\_  
 SPECIFIER \_\_\_\_\_  
 QUANTITY \_\_\_\_\_  
 DATE \_\_\_\_\_

### Fixture Finish

Sparkling Silver - 01 (SSR)



Black Velvet - 02 (BKV)



Crystal White - 03 (CWI)



Creamy - 04 (CRY)



Hampton Bay - 05 (HAB)



Urban Forest - 07 (UFT)



In the Army - 08 (ITA)

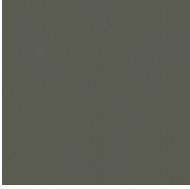

Rusty Angel - 09 (RUA)



Fade to Gray - 12 (FTG)



Mysterious Gray - 13 (MYG)

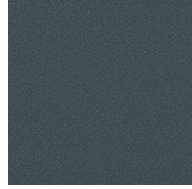

Lost Dream - 15 (LOD)



Purple Sky - 16 (PUS)



Fresh Oh - 17 (FRO)

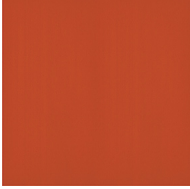

Funky P. - 18 (FUP)



Kissing Aphrodite - 19 (KIA)



Poseidon's Paradise - 20 (POP)



Blue Sky - 21 (BLS)



Spring Green - 22 (SPG)

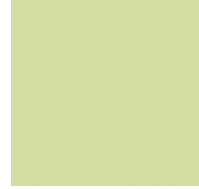

Mellow Yellow - 23 (MEY)

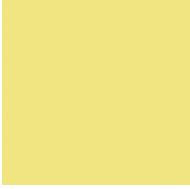

Golden Heart - 24 (GOH)



Gun Metal - 25 (GUM)



Champagne Cream - 26 (CHC)



Copper Mine - 27 (COM)



Ancient Bronze - 28 (ABZ)



Jazz Gold - 29 (JAG)



Olive Breeze - 30 (OBR)



Moonlight Silver - 31 (MOS)



Rosewood Red - 32 (ROR)



### Holder Finish

White - WHI (WHI)



Black - BLK (BLK)



**Digital:** Not all screens are calibrated the same, and therefore, colors will appear differently between screens.

**Physical:** While the physical color swatches are printed on a color calibration target, the character and tone within a product series and between product families.

Available for International specifications by adding 'INT' at the end of the existing Model #. For assistance on 'custom' specifications, contact zteam@zaneen.com.

In a constant supply of the product, the colors are not to change appearance and black color particles which are most visible in the product are being identical.

**Gun Metal, Mellow Yellow, Golden Heart, Jazz Gold, Moonlight Silver, Rosewood Red, Champagne Cream, Copper Mine, Ancient Bronze + Jazz Gold:** These finishes have slight fading from specific powder coating production. Each luminaire will slightly vary.

|           |  |
|-----------|--|
| PROJECT   |  |
| TYPE      |  |
| SPECIFIER |  |
| QUANTITY  |  |
| DATE      |  |

### LEGEND

|   |  |  |
|---|--|--|
| floor-mounted   | pivotal  | special LED (upon request) RGB, RGBW, tunable, gold+, meat+, art+, fashion+                    |
| wall and ceiling: recessed and surface mounted            | rotating   | warm dim / natural dimming LED   |
| ceiling-mounted and wall-mounted                          | illuminate tilted  | rechargeable battery powered   |
| wall-mounted  | color of suspension cable                                    | fixture with natural vivid LED (upon request)  |
| omni-directional light distribution                       | length of suspension cable                                   | color rendering index  |
| direct light distribution                                 | reflector degree selection                                   | color temperature  |
| direct/indirect light distribution                        | super spot   | lumen (luminous flux)  |
| indirect light distribution                               | lens   | efficacy (lumens per watt)   |
| asymmetric light distribution                             | lens pack  | Unified Glare Rating (UGR) range from 5-40   |
| aura light distribution                                   | shine ring   | marine grade (AISI 316 stainless steel)  |
| round wall or ceiling cut-out                             | integrated shine ring with diffuser                          | walk on  |
| square wall or ceiling cut-out                            | free individual colors 01-29                                 | drive on   |
| the supplied jig specifies the cutout dimensions          | individual colors: 00 (free of charge), 01-25 (extra charge) | Dark Sky Compliance  |
| minimum distance (meters) lamp - object                   | luminaire part to be colored (F1)                            | Americans with Disabilities Act (less than 4" off the wall located between 27"-84" from floor) |
| recessed depth  | luminaire part to be colored (F2)                            | lamp protected against explosion   |
| ceiling thickness in mm                                   | luminaire part to be colored (F3)                            | blown glass using traditional methods by master glass blower                                   |
| ceiling thickness selection                               | luminaire part to be colored (F4)                            | acoustic material  |
| dimmable DP (phase), DV (0-10V), DD (dali), DS (step-dim) | luminaire part to be colored (F5)                            | protection class I, protection insulation  |
| included or excluded LED driver/transformer/control gear  | color of 3-circuit adaptor                                   | protection class II, protection insulation   |
| separately switchable                                     | indirect diffuser  | ETL Certified to UL and CSA Standards  |
| sensor  | direct diffuser  | UL Certified to UL and CSA Standards   |
| remote control  | ball-proof (upon request)                                    | CSA Certified to UL and CSA Standards  |
| available upon request                                    | accessory  | Certified for North American Standards   |

### IP RATING

|      |  |
|------|--|
| IP20 | protected against ingress of solid bodies greater than 12.5mm (finger)   |
| IP33 | protected against ingress of solid bodies greater than 2.5mm<br>protected against sprays of water up to 60 degrees from the vertical (rain)      |
| IP40 | protected against ingress of solid bodies greater than 1mm (wire)<br>no protection against the ingress of moisture                               |
| IP43 | protected against ingress of solid bodies greater than 1mm (wire)<br>protected against sprays of water up to 60 degrees from the vertical (rain) |
| IP44 | protected against ingress of solid bodies greater than 1mm (wire)<br>protected against water splashed from all directions                        |
| IP54 | protected against limited ingress of dust (wet rooms/covered outdoor areas)<br>protected against water splashed from all directions              |
| IP65 | protected against ingress of dust<br>protected against jets of water   |
| IP66 | protected against ingress of dust<br>protected against powerful jets of water or heavy seas  |
| IP67 | protected against ingress of dust<br>protected against immersion of water between 15cm - 1m for 30 minutes                                       |
| IP68 | protected against ingress of dust<br>protected against immersion of water under pressure for long periods  |

### IK RATING

|      |   |
|------|---|
| IK01 | protected against 0.14 joules impact (equivalent to 0.25kg mass dropped from 56mm above the surface)  |
| IK02 | protected against 0.2 joules impact (equivalent to 0.25kg mass dropped from 80mm above the surface)   |
| IK03 | protected against 0.35 joules impact (equivalent to 0.25kg mass dropped from 140mm above the surface) |
| IK04 | protected against 0.5 joules impact (equivalent to 0.25kg mass dropped from 200mm above the surface)  |
| IK05 | protected against 0.7 joules impact (equivalent to 0.25kg mass dropped from 280mm above the surface)  |
| IK06 | protected against 1 joules impact (equivalent to 0.25kg mass dropped from 400mm above the surface)    |
| IK07 | protected against 2 joules impact (equivalent to 0.5kg mass dropped from 400mm above the surface)     |
| IK08 | protected against 5 joules impact (equivalent to 1.7kg mass dropped from 300mm above the surface)     |
| IK09 | protected against 10 joules impact (equivalent to 5.0kg mass dropped from 200mm above the surface)    |
| IK10 | protected against 20 joules impact (equivalent to 5.0kg mass dropped from 400mm above the surface)    |